

DETECTO PARTS

DETECTO HEAD KIT

ORDER NO.	PART NO.	DESCRIPTION	PRICE	NET
N100		Detecto Head Kit Includes N001 Ribbons, Roller, Yoke Assy, 2 Brass Rollers/pins, 6 Chrome Bearings (also Choice of Pinion, Standard N011)	\$ 675.00	\$ 472.50

DETECTO PARTS

ORDER NO.	PART NO.	DESCRIPTION	PRICE	NET
N001	257GR14	Ribbons 2/pkg 1/2" Wide x .005 With End Clip	\$ 165.50	\$ 115.85
N010	434GR33	Roller Yoke Assembly	175.00	122.50
N011	530G2	Pinion 7.125 Long	145.00	101.50
N013	530R79	Pinion, Pointer Shaft 5.9375 Long	125.00	87.50
N015	530R730	Pinion, Assembly 6.500 Long	135.00	94.50
N016	530GR739	Pinion, Extended End 6.625 Long	145.00	101.50
N017	530GR749	Pinion, Extended End 6.625 Long	119.00	83.30
N020	574R73W/P	2 Brass Rollers + 2 Roller Pins	65.00	45.50
N021	581R33	Bearing Shim .005 6/pkg	30.00	21.00
N022	561R613	Pendulum Shaft Stainless Steel (2 Pcs/Pk)	145.00	101.50
N028	1529-B019	Cap, Bearing (4 Reqd.)	16.00	11.20
N029	1529-B018	Cap, Bearing With Hole (2 Pcs/Pkg.)	17.50	12.25
N222	1529-B059	Rubber Bumper And Bolt (2 Pcs/Pkg.)	15.50	10.85
N242	1529-B010	Dust Cap, Bearing (4 Pcs/Pkg.)	15.50	10.85
N254	1529-C018	Back Cover	110.00	77.00
N258	ASSY-K	Dash Pot Assembly	180.00	94.00
N262	1529-C058	Front Scroll	98.50	68.95
N263	1529-B058	Dial Cover, 23-9/16" Diameter	185.00	129.50
N266	1529-C002	Sector/Shaft Assembly Left Hand	230.00	115.00
N278	ASSY-J	Indicator Assembly	98.50	68.95

DETECTO BEARINGS

ORDER NO.	DESCRIPTION	PRICE	NET
U550	Bearing, Chrome Steel, 1 - 6 pcs	\$ 14.50	\$ 10.15
U-555	Bearing, Corrosion Resistant, Stainless Steel, 1- 6 pcs.	20.30	14.21

DETECTO SLOTTED WEIGHTS

ORDER NO.	DESCRIPTION	PRICE	NET
N620	100 lb x 1 lb Slotted Weight, Round	\$ 14.00	\$ 9.80
N621	200 lb x 2 lb Slotted Weight, Round	16.00	11.20
N622	500 lb x 5 lb Slotted Weight, Round	32.00	22.40
N623	500 lb x 2.5 lb Slotted Weight, Round	32.00	22.40
N624	100 kg x 1 kg Slotted Weight, Round	17.50	12.25
N625	200 kg x 2 kg Slotted Weight, Round	22.00	15.40
N626	50 kg x 500 g Slotted Weight, Round	32.00	22.40

DETECTO PARTS

ENGRAVED BARS, TARE/CAPACITY, AVAILABLE, CALL FOR DETAILS
MANY OTHER DETECTO SCALE PARTS ARE AVAILABLE
THE FOLLOWING SCALES USE DETECTO HEADS
WINSLOW HARDY THURMAN CARDINAL CHATILLON CORBITT

L675 PORTABLE BEAM REPLACEMENT PARTS

ORDER NO.	DESCRIPTION	PRICE	NET
N609	Beam Tip Hanger	\$ 15.00	\$ 10.50
N628	Counterpoise Assembly	24.00	16.80

DIAGRAMS PAGES 3 THRU 5



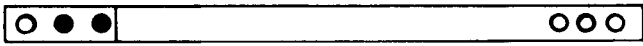

N001—RIBBON
 $\frac{1}{2}$ " x .005 x 8-1/2" Long

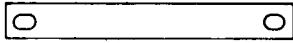

N002—RIBBON
 $\frac{1}{2}$ " x .004 x 3 $\frac{3}{8}$ " cc
 Special

N002-1—RIBBON
 $\frac{1}{2}$ " x .005 x 3 $\frac{3}{8}$ " cc
 Special

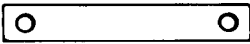

N003—RIBBON
 $\frac{1}{2}$ " x .007 x 2 $\frac{1}{2}$ " cc
 Special



N004—RIBBON
 $\frac{1}{2}$ " x .004 x 1 $\frac{1}{2}$ " cc
 Special

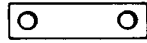

N005—RIBBON
 $\frac{1}{2}$ " x .004 x 1 $\frac{1}{8}$ " cc
 Special

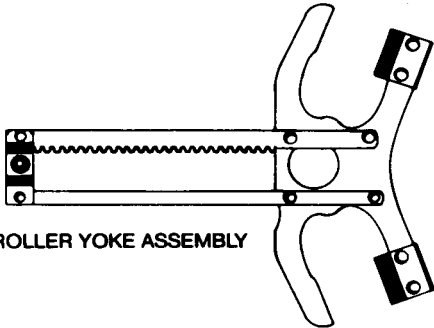

N010—ROLLER YOKE ASSEMBLY



N012—ROLLER PIN

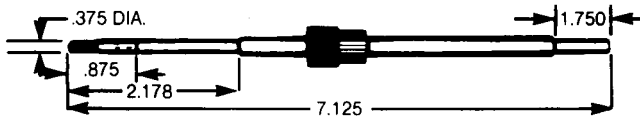

N011—PINION

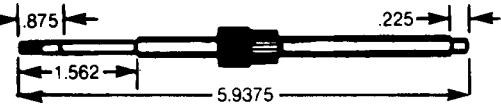

N013—PINION, POINTER SHAFT

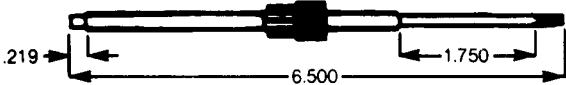

N015—PINION ASSEMBLY

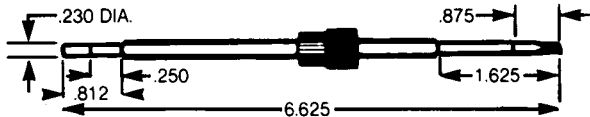

N016—PINION, EXTENDED END

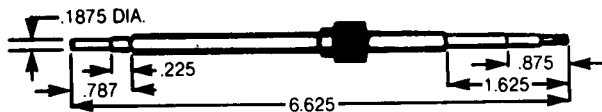

N017—PINION, EXTENDED END



N020—BRASS ROLLER W/PIN KIT



N021—BEARING SHIM

DETECTO PARTS



U555 — BEARING, CORROSION RESISTANT
STAINLESS STEEL

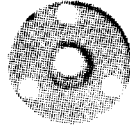

N214 — BEARING CAP, OPEN (2 Req.)



N222 — RUBBER BUMPER W/BOLT (2 Req.)



N210 — CONNECTING LINK (1 Req.)



N242 — BEARING CAP (4 Req.)

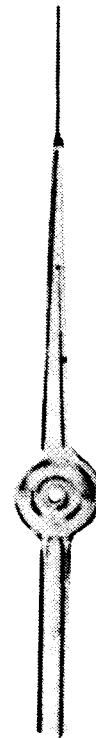

N278 — INDICATOR
ASSEMBLY (1 Req.)